



# Stoeger®

Every Day Tough



## 2024 DEALER WORKBOOK

### A I R G U N S

<b>CONTENTS</b>	<b>68</b>	<b>XM1 Pre-charged Pneumatic</b>	<b>78</b>	<b>S8000-E TAC Tactical</b>
	<b>70</b>	<b>XM1 BullShark PCP</b>	<b>80</b>	<b>S3000-C Compact</b>
	<b>NEW 72</b>	<b>XMI Ranger / Scout PCP</b>	<b>82</b>	<b>Accessories</b>
	<b>74</b>	<b>S4000-E Suppressed</b>	<b>83</b>	<b>Price List</b>
	<b>76</b>	<b>S6000-E Underlever</b>		



# XM1

A Next Generation Airgun



**XM1 SUPPRESSED PCP AIRGUN COMBO**  
 .177 CAL, 1200 FPS & .22 CAL, 1000 FPS  
 (Includes 4 x 32 mm scope)

**1200**  
 Feet Per Second\*

**ADVANCED**  
 ERGONOMICS

**MGS**  
 MULTI GRIP SYSTEM

**PROADAPTIVE**  
 CHECKERING

**S4**  
 SUPPRESSOR



**XM1 SUPPRESSED PCP AIRGUN COMBO – REALTREE EDGE**  
 .22 CAL, 1000 FPS  
 (Includes 4 x 32 mm scope)



The XM1 air rifle demonstrates Stoeger's commitment to innovation and cutting-edge technology. It offers superior performance and accuracy with futuristic style. Engineered with exceptional ergonomics, the XM1's weight, balance and sleek profile team with interchangeable cheekpieces and pistol grips and an integrated suppressor to deliver unparalleled shooting comfort. The onboard air reservoir allows multiple shots to be made at consistent velocities between air charges – no pumping between shots. The XM1 comes with fully adjustable fiber-optic sights and combo versions include a 4 x 32 mm scope.

- A.** Interchangeable cheekpieces aid in tailoring the fit of the XM1 to individual shooters.
- B.** Colored recoil-pad spacers adjust length of pull and customize the fit of the air rifle.
- C.** Pistol-grip pieces are interchangeable for a custom fit by adding or reducing palm swell.

### XM1 AIRGUN STANDARD FEATURES

**VELOCITY:** .177 Cal. up to 1200 fps muzzle velocity with alloy pellets

.22 Cal. up to 1000 fps muzzle velocity with alloy pellets

**ACTION:** Pre-charged pneumatic

**TRIGGER:** Two-stage, adjustable length of pull

**SAFETY:** Cross-bolt

**FINISH:** Realtree® Edge™ Black synthetic

**PROADAPTIVE CHECKERING**

**MULTI-GRIP SYSTEM:** Interchangeable pistol grip pieces for custom fit

**FRONT SIGHT:** Interchangeable red and orange fiber-optic inserts

**REAR SIGHT:** Fiber-optic, fully adjustable for elevation and windage

**SCOPE:** Includes 4 x 32 mm scope (Combos ONLY; scope not factory mounted)

### XM1 AIRGUN

ITEM NUMBER	DESCRIPTION	MSRP
<b>XM1 SUPPRESSED AIRGUN .22 CAL, UP TO 1000 FPS*</b>		
30341	Black Synthetic Combo with 4 x 32 Scope	\$229
30342	Realtree Edge Combo with 4 x 32 Scope	\$249
<b>XM1 SUPPRESSED AIRGUN .177 CAL, UP TO 1200 FPS*</b>		
30319	Black Synthetic Combo with 4 x 32 Scope	\$229
<b>XM1 AIRGUN .177 CAL, UP TO 1200 FPS*</b>		
30318	Black Synthetic with Fiber-Optic Sights	\$199
<b>XM1 SUPPRESSED AIRGUN .22 CAL. &amp; HAND PUMP COMBO</b>		
30409	Black Synthetic Combo with 4 x 32 Scope & Hand Pump	\$299
<b>XM1 SUPPRESSED AIRGUN .177 CAL. &amp; HAND PUMP COMBO</b>		
30408	Black Synthetic Combo with 4 x 32 Scope & Hand Pump	\$299

COMMON SPECIFICATIONS: **Caliber:** .177 \***Velocity:** up to 1200 fps with alloy pellet (1000 fps with lead pellet) **Caliber:** .22 \***Velocity:** up to 1000 fps with alloy pellet (800 fps with lead pellet) **Trigger:** Two-stage adjustable **Type of Scope:** combos include 4 x 32 Scope

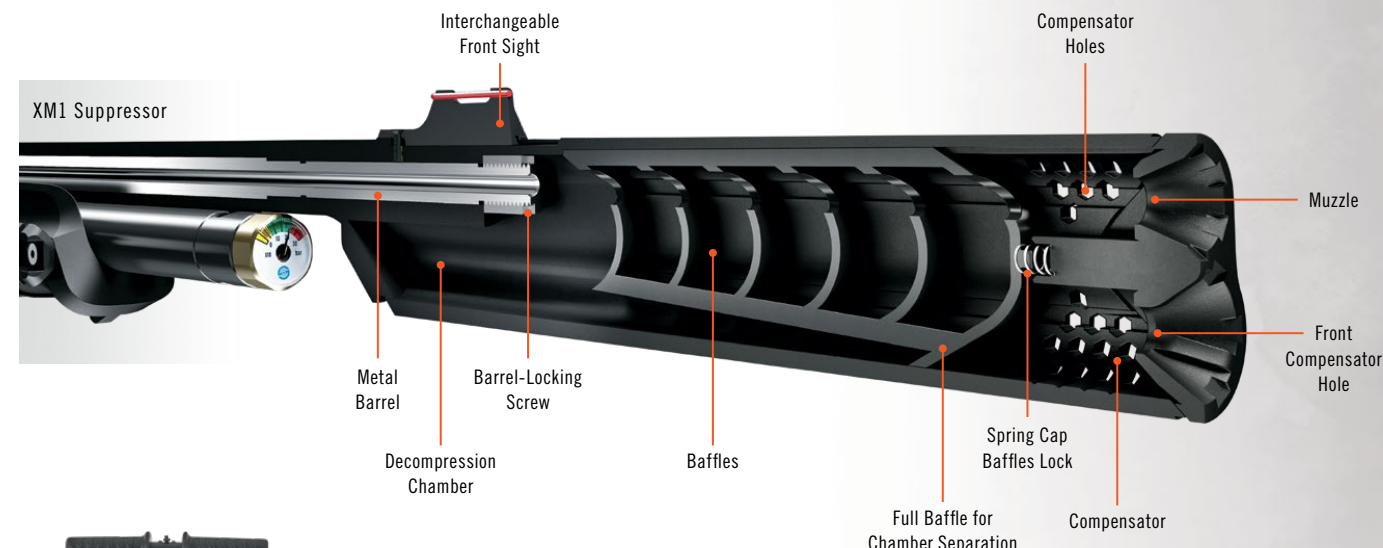

**PCP AIRGUN HAND PUMP**  
 Item # 30387  
 \$149



EBL (ergonomic bolt lever) is the first lever with exclusive THRIDION checkering for maximum grip.



The left-side Picatinny rail extension contains locking magnets to offer storage for up to three additional rotary magazines (extra magazines not included).



The XM1's removable air gauge cover offers a quick way to check remaining air pressure in the air rifle (cover not included on non-suppressed models).

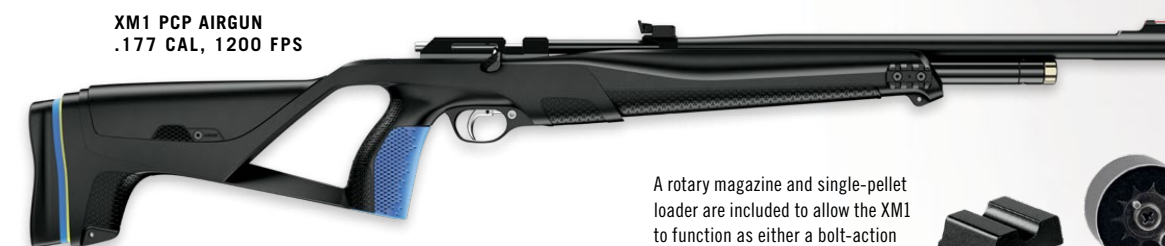

**XM1 PCP AIRGUN**  
 .177 CAL, 1200 FPS

A rotary magazine and single-pellet loader are included to allow the XM1 to function as either a bolt-action repeater or a single-shot air rifle.





# XM1 Bullshark

Consistent Power and Accuracy in a Compact Design



**XM1 BULLSHARK SUPPRESSED PCP AIRGUN**  
 .177 CAL, 1200 FPS,  
 .22 CAL, 1100 FPS,  
 .25 CAL, 1000 FPS



Interchangeable cheek pieces team with colored recoil-pad spacers to customize the XM1's fit to individual shooters for optimal shooting comfort.



The XM1 Bullshark air rifle leaves no doubt that Stoeger leads the world in airgun innovation. Its groundbreaking bullpup configuration combined with an integrated suppressor, virtually no recoil and Olympic-grade accuracy (using premium pellets) delivers a whole new level of compact handling, maneuverability and performance. Adjustment features include recoil pad spacers, cheek pieces and grips to ensure a custom fit, and advanced ergonomics provide optimal shooting comfort. A two-stage, adjustable trigger enhances accuracy. Picatinny rails on the top and side for optics and lights. Step into the future of airguns with the XM1 Bullshark from Stoeger.

### XM1 BULLSHARK AIRGUN STANDARD FEATURES

- VELOCITY:** .177 Cal. up to 1200 fps muzzle velocity with alloy pellets / 970 fps with lead pellets
- .22 Cal.** up to 1100 fps muzzle velocity with alloy pellets / 910 fps with lead pellets
- .25 Cal.** up to 1000 fps muzzle velocity with alloy pellets / 830 fps with lead pellets
- ACTION:** Pre-charged pneumatic
- TRIGGER:** Two-stage adjustable
- SAFETY:** Manual cross-bolt
- FINISH:** Black synthetic
- PROADAPTIVE CHECKERING**
- MULTI-GRIP SYSTEM:** Interchangeable pistol grip pieces for custom fit

### XM1 BULLSHARK AIRGUN

ITEM NUMBER	DESCRIPTION	MSRP
<b>XM1 BULLSHARK SUPPRESSED AIRGUN .25 CAL, UP TO 1000 FPS*</b>		
30438	Black Synthetic Stock with Multi Grip System & Buttstock Spacers	\$479
<b>XM1 BULLSHARK SUPPRESSED AIRGUN .22 CAL, UP TO 1100 FPS*</b>		
30437	Black Synthetic Stock with Multi Grip System & Buttstock Spacers	\$479
<b>XM1 BULLSHARK SUPPRESSED AIRGUN .177 CAL, UP TO 1200 FPS*</b>		
30436	Black Synthetic Stock with Multi Grip System & Buttstock Spacers	\$479

COMMON SPECIFICATIONS: **Caliber:** .177 \***Velocity:** up to 1200 fps with alloy pellet (970 fps with lead pellet) **Caliber:** .22 \***Velocity:** up to 1100 fps with alloy pellet (910 fps with lead pellet) **Caliber:** .25 \***Velocity:** up to 1000 fps with alloy pellet (830 fps with lead pellet) **Trigger:** Two-stage adjustable

FPS = FEET PER SECOND  
 SPECIFICATIONS AND PRICES SUBJECT TO CHANGE WITHOUT NOTICE.

**1200**  
 Feet Per Second\*

**MGS**  
 MULTI GRIP SYSTEM

**ADVANCED ERGONOMICS**

**PROADAPTIVE CHECKERING**

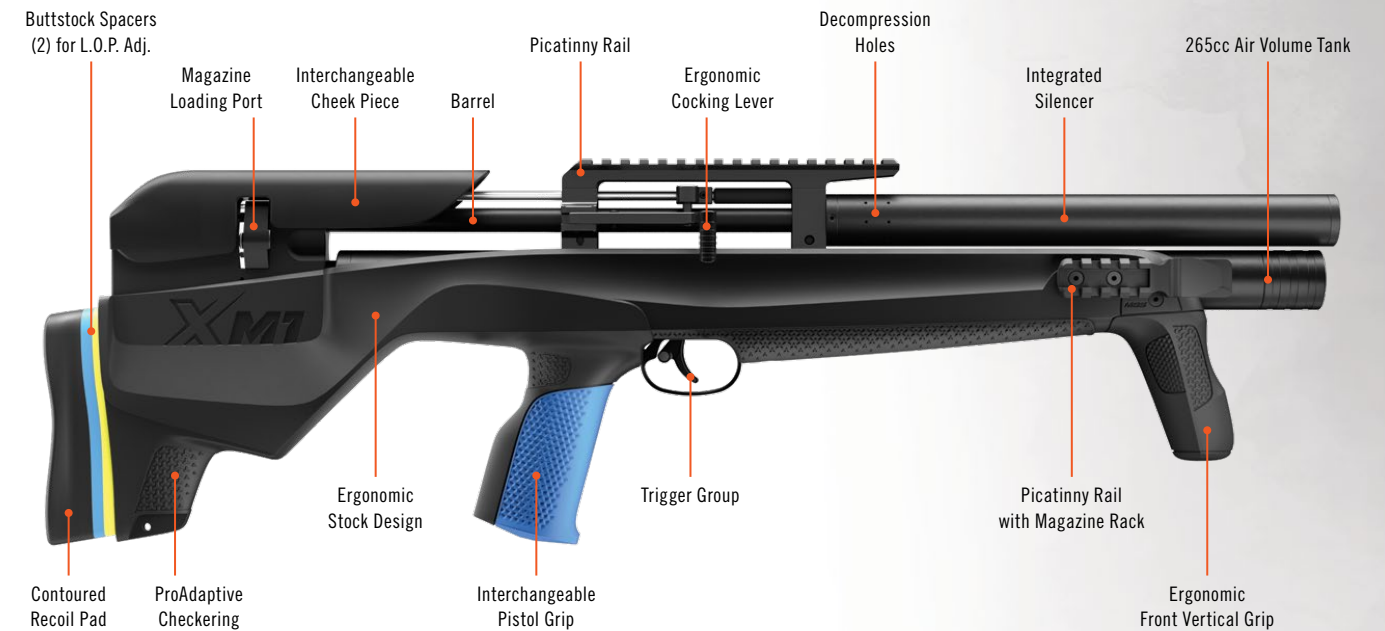

**A.** Each Bullshark comes with two rotary magazines and is available in .177, .22, and 25 caliber.



**B.** Interchangeable pistol-grips enhance the fit by adding or reducing palm swell.



**C.** Attach military-style front vertical grip for added control and maneuverability, or use the flush-mounting plate as desired.



# XM1

Hunting Style Rifle



**NEW** XM1 RANGER PCP AIRGUN  
.22 CAL, 1000 FPS,  
.25 CAL, 900 FPS

## XM1 RANGER



**NEW** XM1 SCOUT PCP AIRGUN  
.22 CAL, 900 FPS,  
.25 CAL, 800 FPS

## XM1 SCOUT



Interchangeable cheek pieces team with recoil-pad spacers to customize the XM1's fit to individual shooters for optimal shooting comfort.



Taking Stoeger's innovative XM1 full-size airgun platform to more compact dimensions, the all-new XM1 Ranger and XM1 Scout models satisfy the go-light, go-fast criteria of today's hunting airgun enthusiasts. Boasting a shorter overall length than the original XM1, the XM1 Ranger (43.2-inch OAL) and the XM1 Scout (37.7-inch OAL) sacrifice nothing in terms of ergonomics and performance. With their fully adjustable stock system (LOP, cheek riser height, grip) and trigger pull weight, these PCP airguns ensure a custom fit for shooters of all sizes as well as for seasonal changes in clothing. Powered by a 200cc tank, capable of up to 1,000 fps\*, and boasting a high-capacity rotary magazine for fast, reliable chambering, the XM1 Ranger and XM1 Scout cause steel targets, pests, and small game to shudder!

### XM1 SCOUT AIRGUN STANDARD FEATURES

- ACTION:** Straight Pull
- TRIGGER:** Three lever - Adjustable from 0.6 to 0.35 Kg
- SAFETY:** Manual on trigger
- FINISH:** Black synthetic
- MULTI-GRIP SYSTEM:** Interchangeable pistol grip pieces for custom fit

FPS = FEET PER SECOND  
SPECIFICATIONS AND PRICES SUBJECT TO CHANGE WITHOUT NOTICE.  
StoegerIndustries.com

### XM1 SCOUT / RANGER AIRGUN

ITEM NUMBER	DESCRIPTION	MSRP
<b>NEW</b> 30462	Black Synthetic Stock with Multi Grip System & Buttstock Spacers <b>XM1 SCOUT AIRGUN .25 CAL, UP TO 800 FPS*</b>	\$329
<b>NEW</b> 30461	Black Synthetic Stock with Multi Grip System & Buttstock Spacers <b>XM1 SCOUT AIRGUN .22 CAL, UP TO 900 FPS*</b>	\$329
<b>NEW</b> 30464	Black Synthetic Stock with Multi Grip System & Buttstock Spacers <b>XM1 RANGER AIRGUN .25 CAL, UP TO 900 FPS*</b>	\$349
<b>NEW</b> 30463	Black Synthetic Stock with Multi Grip System & Buttstock Spacers <b>XM1 RANGER AIRGUN .22 CAL, UP TO 1000 FPS*</b>	\$349

COMMON SPECIFICATIONS: **Caliber:** .22 Scout: up to 900 fps with alloy pellet; .25 Scout: up to 800 fps with alloy pellet **Caliber:** .22 Ranger: up to 1000 fps with alloy pellet; **Caliber:** .25 Ranger: up to 900 fps with alloy pellet **Trigger:** Two-stage adjustable



Buttstock Spacers (2) for L.O.P. Adj.

Contoured Recoil Pad

Interchangeable Cheek Piece

Ergonomic Stock Design

Straight Pull Loading System

Interchangeable Pistol Grip

Hi-Capacity Magazine

Picatinny Rail

Adjustable Trigger Pull

Decompression Chamber & Holes

Air Regulator Gauge

Free Floating Barrel

Flat Forehand

200cc Air Volume Tank

Picatinny Rail with Magazine Rack

Threaded Muzzle

Air Tank Gauge

A. Each airgun comes with two rotary magazines and is available in .22, and 25 caliber.

B. Interchangeable pistol-grips enhance the fit by adding or reducing palm swell.

C. 3 picatinny rail segments





# S4000-E

Superior Performance



**1200**  
Feet Per Second\*



**S4000-E SUPPRESSED AIRGUN COMBO – REALTREE EDGE**  
.177 CAL, 1200 FPS & .22 CAL, 1000 FPS  
(Includes 4 x 32 mm scope)



Stoeger introduces the next generation of airgun technology in its fast-shooting, hard-hitting, yet quiet S4000-E. It comes with multiple features to customize the fit and feel, including MGS and ProAdaptive Checkering technologies. The integrated S3 suppressor dramatically reduces shot noise. A recoil-absorbing buttpad makes shooting a joy. Other features include an ambidextrous safety, adjustable two-stage trigger, and interchangeable fiber-optic bars for the front sight. The rifled barrel teams with the included scope to deliver impressive accuracy shot after shot. Step into the future of airguns with S4000-E.



**S4000-E SUPPRESSED AIRGUN COMBO**  
**OD GREEN, .22 CAL, 1000 FPS**  
(Includes 4 x 32 mm scope)

The ergonomically designed S4000-E suppressor shroud also serves as the cocking grip – allowing for easy operation of the powerful Gas Ram System break-barrel action.



**S4000-E SUPPRESSED AIRGUN**  
**HARDWOOD, .177 CAL, 1200 FPS**  
(Includes 4 x 32 mm scope)



Multi-Grip System lets shooters adapt their air rifle for personalized style and shooting comfort. Choose between an embossed grip or Stoeger's innovative ProAdaptive Checkering.



ProAdaptive Checkering is the most versatile, efficient and innovative stock checkering available. It allows shooters to feel like the airgun is a natural extension of their bodies, resulting in quick, instinctive aiming and enhanced shooting comfort. The unique checkering progression actively and comfortably "fits" the gun to the shooter in any weather or shooting venue.

### S4000-E AIRGUN STANDARD FEATURES

- VELOCITY:** .177 Cal. up to 1200 fps muzzle velocity with alloy pellets (1000 fps with lead pellets), .22 Cal. up to 1000 fps muzzle velocity with alloy pellets (800 fps with lead pellets)
- ACTION:** Powerful break-action Gas Ram piston
- TRIGGER:** Two-stage adjustable
- SAFETY:** Automatic ambidextrous
- FINISHES:** Realtree® Edge™, OD Green, Hardwood, Black synthetic
- PROADAPTIVE CHECKERING**
- MULTI-GRIP SYSTEM:** Interchangeable blue and orange embossed grips included (not available on hardwood model)
- FRONT SIGHT:** Interchangeable red and orange fiber-optic inserts
- REAR SIGHT:** Fiber-optic, fully adjustable for elevation and windage
- SCOPE:** Includes 4 x 32 mm scope (Combos ONLY; scope not factory mounted)

FPS = FEET PER SECOND

SPECIFICATIONS AND PRICES SUBJECT TO CHANGE WITHOUT NOTICE.

### S4000-E SUPPRESSED AIRGUN

ITEM NUMBER	DESCRIPTION	MSRP
<b>S4000-E .177 CAL, UP TO 1200 FPS*</b>		
30401	Realtree Edge Stock Combo with 4 x 32 Scope	\$199
30361	Hardwood Stock Combo with 4 x 32 Scope	\$199
30313	Black Synthetic Stock Combo with 4 x 32 Scope	\$179
30312	Black Synthetic Stock with Fiber-Optic Sights	\$149
<b>S4000-E .22 CAL, UP TO 1000 FPS*</b>		
30399	Realtree Edge Stock Combo with 4 x 32 Scope	\$199
30360	OD Green Stock Combo with 4 x 32 Scope	\$199
30314	Black Synthetic Stock Combo with 4 x 32 Scope	\$179
30315	Black Synthetic Stock with Fiber-Optic Sights	\$149

COMMON SPECIFICATIONS: **Caliber:** .177 \***Velocity:** up to 1200 fps with alloy pellet (1000 fps with lead pellet) **Caliber:** .22 \***Velocity:** up to 1000 fps with alloy pellet (800 fps with lead pellet) **Trigger:** Two-stage adjustable **Type of Scope:** combos include 4 x 32 Scope

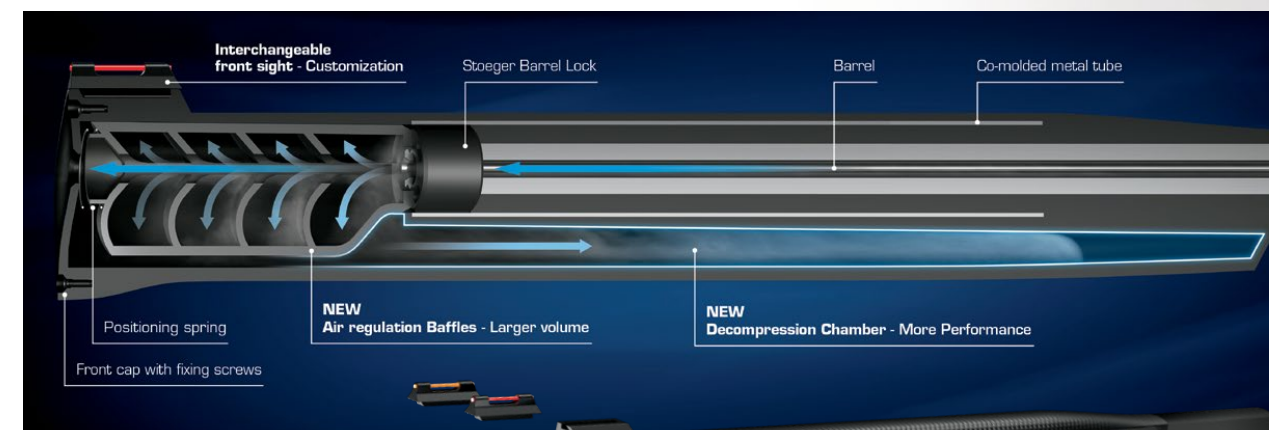

The new, patented Stoeger S3 Suppressor combines the functionality of internal air-regulating baffles with a newly developed decompression chamber. These work together to significantly reduce noise. The S3 Suppressor is the first suppressor system in the world to feature interchangeable front fiber-optic sights.



# S6000-E

Fixed Barrel with Underlever Cocking



**S6000-E UNDERLEVER AIRGUN COMBO – BLACK SYNTHETIC**  
 .177 CAL, 1200 FPS & .22 CAL, 1000 FPS  
 (Includes 4 x 32 mm scope)



**1200**  
 Feet Per Second\*

**MIGS**  
 MULTI GRIP SYSTEM

**PRO ADAPTIVE**  
 CHECKERING

**Easy-Access**  
 Magazine

**UNDERLEVER**  
 COCKING



**MIGS**  
 MULTI GRIP SYSTEM

Multi-Grip System lets shooters adapt their air rifle for personalized style and shooting comfort. Choose between an embossed grip or Stoeger's innovative ProAdaptive Checkering.



Recreational



Pest Control



Small Game

As any airgun diehard will tell you, underlevers offer a number of substantial advantages over break-barrels. These advantages are perfectly embodied in the Stoeger S6000-E airgun. First, this design offers perfect rigidity between the barrel and the receiver, which affects accuracy positively. Then, there is considerably less wear to the airgun's most important part—where the barrel meets the receiver and at the hinge-pin. Also, the extra weight of the cocking lever is ideally placed under the barrel, making the rifle steadier in your hands when you shoot. Try the S6000-E yourself—it will make you a fan.



**UNDERLEVER**  
 COCKING

The S6000-E has a fixed barrel, which means that every shot is mechanically consistent with the next one. The underlever is long, requiring less effort to operate it. When not in use, the underlever locks positively under the barrel and adds balance to the rifle.

**ADVANCED**  
 ERGONOMICS



**S6000-E UNDERLEVER AIRGUN COMBO – HARDWOOD**  
 .177 CAL, 1200 FPS & .22 CAL, 1000 FPS  
 (Includes 4 x 32 mm scope)

**S6000-E UNDERLEVER AIRGUN STANDARD FEATURES**

- VELOCITY:** .177 Cal. up to 1200 fps muzzle velocity with alloy pellets (1000 fps with lead pellets), .22 Cal. up to 1000 fps muzzle velocity with alloy pellets (800 fps with lead pellets)
- ACTION:** Powerful spring piston, Underlever cocking
- TRIGGER:** Two-stage adjustable
- SAFETY:** Automatic ambidextrous
- FINISHES:** Hardwood, Black synthetic
- PROADAPTIVE CHECKERING**
- MULTI-GRIP SYSTEM:** Interchangeable blue and orange embossed grips included (not available on hardwood model)
- FRONT SIGHT:** Hooded front sight with red fiber-optic insert
- REAR SIGHT:** Fiber-optic, fully adjustable for elevation and windage
- SCOPE:** Includes 4 x 32 mm scope

**S6000-E UNDERLEVER AIRGUN**

ITEM NUMBER	DESCRIPTION	MSRP
<b>S6000-E .177 CAL, UP TO 1200 FPS*</b>		
30404	Black Synthetic Stock Combo with 4 x 32 Scope	\$199
30402	Hardwood Stock Combo with 4 x 32 Scope	\$229
<b>S6000-E .22 CAL, UP TO 1000 FPS*</b>		
30406	Black Synthetic Stock Combo with 4 x 32 Scope	\$199
30403	Hardwood Stock Combo with 4 x 32 Scope	\$229

COMMON SPECIFICATIONS: **Caliber:** .177 \***Velocity:** up to 1200 fps with alloy pellet (1000 fps with lead pellet) **Caliber:** .22 \***Velocity:** up to 1000 fps with alloy pellet (800 fps with lead pellet) **Trigger:** Two-stage adjustable **Type of Scope:** combos include 3-9 x 40 Scope

FPS = FEET PER SECOND  
 SPECIFICATIONS AND PRICES SUBJECT TO CHANGE WITHOUT NOTICE.



**Easy-Access**  
 Magazine



The single-shot flip-up magazine is easily accessible and a snap to load. It is located just behind the fully-adjustable target rear sight.



# S8000-E TAC

Piston-Driven Perfection



**1200**  
Feet Per Second\*



**S8000-E TAC SUPPRESSED AIRGUN COMBO**  
.177 CAL, 1200 FPS & .22 CAL, 1000 FPS  
(Includes 3-9 x 40 scope)

**GAS-RAM**  
TECHNOLOGY



Recreational

Pest Control

Small Game

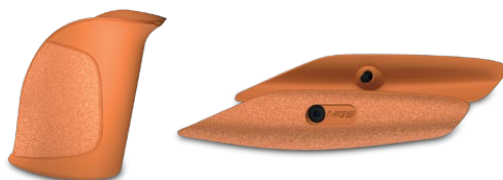

**MGS**  
MULTI GRIP SYSTEM

Stoeger's Multi-Grip System lets shooters adapt their air rifle for personalized style and shooting comfort. Choose between an embossed grip or the innovative ProAdaptive Checkering.

The S8000-E TAC suppressed airgun features Gas-Ram technology, an Airflow Control (AFC) suppressor and a tactical synthetic stock with integrated Picatinny rails attached to both sides of the forend for mounting accessories. The action cocks with a break-open barrel and is driven by the efficient Gas-Ram system that reduces vibration and eliminates the sound that comes from a traditional spring-driven airgun.

## The S8000-E TAC's Gas-Ram system

has been thoroughly tried and tested for toughness and durability, and was chosen for its long-lasting reliability and ballistic precision. Accuracy is enhanced with this system through the elimination of vibrations, and velocities are consistent because of exact and repeatable gas-pressure release.

### S8000-E TAC SUPPRESSED AIRGUN

ITEM NUMBER	DESCRIPTION	MSRP
<b>S8000-E TAC .177 CAL, UP TO 1200 FPS*</b>		
30433	Black Synthetic Combo with 3-9 x 40 Scope	\$249
<b>S8000-E TAC .22 CAL, UP TO 1000 FPS*</b>		
30434	Black Synthetic Combo with 3-9 x 40 Scope	\$249

COMMON SPECIFICATIONS: **Caliber:** .177 \***Velocity:** up to 1200 fps with alloy pellet (1000 fps with lead pellet) **Caliber:** .22 \***Velocity:** up to 1000 fps with alloy pellet (800 fps with lead pellet) **Trigger:** Two-stage adjustable **Type of Scope:** combos include 3-9 x 40 adjustable objective scope

FPS = FEET PER SECOND

SPECIFICATIONS AND PRICES SUBJECT TO CHANGE WITHOUT NOTICE.

As an optional accessory Stoeger Airguns offers folding bipod legs that can be easily attached to the Picatinny rails on the S8000-E TAC's forend.  
ITEM # 90429 MSRP \$35



Integral Picatinny Rails

The tactical-style stock employs integral Picatinny rails, making the attachment of accessories such as lasers, lights, bipods, and sling studs quick and easy.



Optional S8000-E TAC Sling Stud  
ITEM # 90430 MSRP \$10



Optional S8000-E TAC Sling  
ITEM # 90428 MSRP \$10



The S8000-E TAC's tactical-style stock features buttstock spacers that can be added or removed from in front of the recoil pad to adjust the airgun's length of pull (LOP). Fit can be further customized with the three-position cheek piece.

### S8000-E TAC STANDARD FEATURES

**VELOCITY:** .177 Cal. up to 1200 fps muzzle velocity with alloy pellets (1000 fps with lead pellets), .22 Cal. up to 1000 fps muzzle velocity with alloy pellets (800 fps with lead pellets)

**ACTION:** Powerful break-action Gas-Ram piston

**TRIGGER:** Two-stage adjustable

**SAFETY:** Automatic ambidextrous

**FINISH:** Black Synthetic

**PROADAPTIVE CHECKERING**

**MULTI-GRIP SYSTEM:** Interchangeable blue and orange embossed grips included

**SCOPE:** Includes 3-9 x 40 mm adjustable objective scope (not factory mounted)

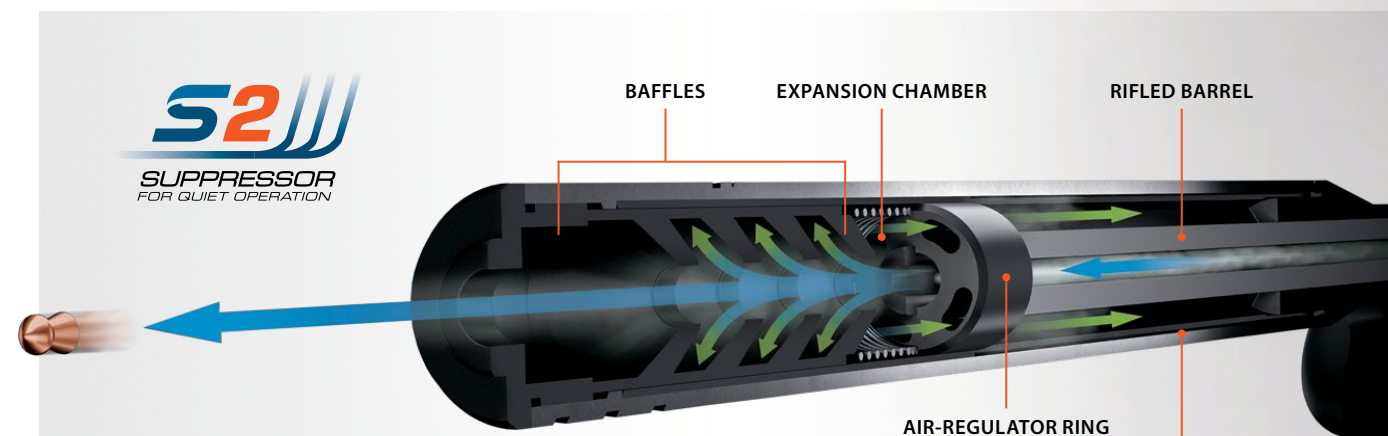

## Dual-Stage Noise Reduction System™

The S<sup>2</sup> Suppressor utilizes the Dual-Stage Noise Reduction System™. This system combines the functions of an internal air-regulator ring with baffles that work in tandem to substantially reduce noise.



# S3000-C

Ergonomically-Enhanced Compact Airgun



**S3000-C AIRGUN COMBO – HARDWOOD**  
 .177 CAL, 810 FPS  
 (Includes 4 x 32 mm scope)

**810**  
 Feet Per Second\*



**S3000-C AIRGUN COMBO – BLACK SYNTHETIC**  
 .177 CAL, 810 FPS  
 (Includes 4 x 32 mm scope)



ProAdaptive Checkering is the most versatile, efficient and innovative stock checkering available. It allows shooters to feel like the airgun is a natural extension of their bodies, resulting in quick, instinctive aiming and enhanced shooting comfort. The unique checkering progression actively and comfortably “fits” the gun to the shooter in any weather or shooting venue.

The S3000-C demonstrates Stoeger’s commitment to innovation and excellence by incorporating the latest in airgun technology. Advanced ergonomics and ProAdaptive Checkering make the gun feel as though it was made just for you. Aiming becomes almost instinctive. The fully adjustable rear sight and fiber-optic front sight offer a clear sight picture, even in low light. An ambidextrous safety accommodates both right- and left-handed shooters. The state-of-the-art recoil pad enhances shooting enjoyment. Combo includes a 4x32 mm scope.



Recreational



Pest Control



Small Game

### S3000-C AIRGUN STANDARD FEATURES

- VELOCITY:** .177 Cal. up to 810 fps muzzle velocity with alloy pellets (660 fps with lead pellets)
- ACTION:** Powerful spring piston, break-action
- TRIGGER:** Double-stage, factory set
- SAFETY:** Automatic ambidextrous
- FINISHES:** Hardwood, Black synthetic
- PROADAPTIVE CHECKERING**
- FRONT SIGHT:** Red fiber-optic
- REAR SIGHT:** Fiber-optic, fully adjustable for elevation and windage
- SCOPE:** Includes 4 x 32 mm scope (Combos ONLY; scope not factory mounted)

### S3000-C COMPACT AIRGUN

ITEM NUMBER	DESCRIPTION	MSRP
<b>S3000-C .177 CAL, UP TO 810 FPS*</b>		
30362	Hardwood Stock Combo with 4 x 32 Scope	\$149
30317	Black Synthetic Stock Combo with 4 x 32 Scope	\$119
30316	Black Synthetic Stock with Fiber-Optic Sights	\$99

COMMON SPECIFICATIONS: **Caliber:** .177 \***Velocity:** up to 810 fps with alloy pellet (660 fps with lead pellet) **Trigger:** Two-stage adjustable **Type of Scope:** combos include 4 x 32 Scope

FPS = FEET PER SECOND

SPECIFICATIONS AND PRICES SUBJECT TO CHANGE WITHOUT NOTICE.



Automatic, ambidextrous safety includes ProAdaptive Checkering



Recoil-absorbing airgun butt pad with anti-slip ProAdaptive Checkering



Fiber-optic front sight with red insert



# Accessories

From Pellets & Targets  
to Soft Gun Cases



**AIRGUN PELLET TRAP**  
ITEM # 30353

**HEAVY-PAPER AIRGUN TARGETS**  
ITEM # 30354

**STOGER AIRGUNS  
SOFT CASE**  
ITEM # 30357

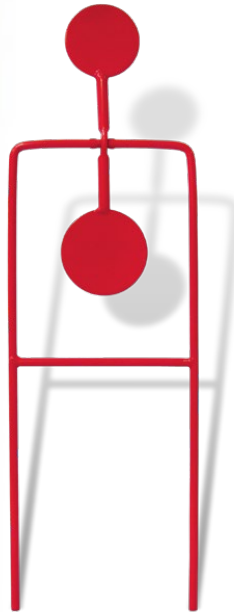

**SINGLE SPINNING  
METAL TARGET**  
ITEM # 30351

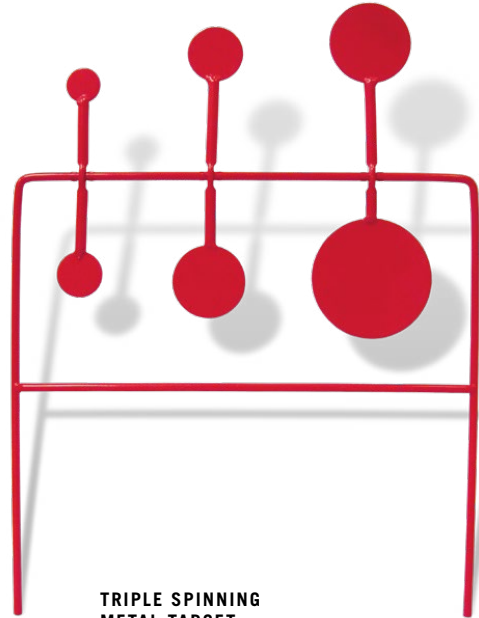

**TRIPLE SPINNING  
METAL TARGET**  
ITEM # 30352



**PCP AIRGUN  
HAND PUMP**  
ITEM # 30387



**S8000-TAC SLING  
ATTACHMENT STUD  
FOR PICATINNY RAIL**  
ITEM # 90430



**S8000-TAC SLING**  
ITEM # 90428

**S8000-TAC BIPOD  
FOR PICATINNY RAIL**  
ITEM # 90429



**ASSORTED PRECISION PELLETS  
AVAILABLE IN .177, .22 AND .25 CALIBER**

X-Field



X-Sport



X-Power



X-Hunt



X-Magnum



X-Match



# 2024 Authorized Commercial Dealer Price List

AUTHORIZED DEALER TOLL FREE NUMBER: 800-264-4962, FAX: 301-283-6988

STOEGER AIRGUNS – EFFECTIVE JANUARY 1, 2024

Specifications and Prices Subject to Change Without Notice.  
This price supersedes all previously issued price lists.

Item Number	Description	UPC Code	MSRP
<b>XM1 S4 Suppressor/Advanced Ergonomics Stock with Multi-Grip System/Pre-Charged Pneumatic</b>			
30318	Non-Suppressed, Advanced Ergonomics Black Synthetic Stock with Fiber-Optic Sights .177 Cal.	0037084303185	\$199
30319	Advanced Ergonomics Black Synthetic Stock with Fiber-Optic Sights and 4 x 32 Scope .177 Cal.	0037084303192	\$229
30341	Advanced Ergonomics Black Synthetic Stock with Fiber-Optic Sights and 4 x 32 Scope .22 Cal.	0037084303413	\$229
30342	Advanced Ergonomics Realtree® Edge™ Synthetic Stock, Fiber-Optic Sights, 4 x 32 Scope .22 Cal.	0037084303420	\$249
<b>XM1 Scout / Ranger Ergonomics Stock with Multi-Grip System/Pre-Charged Pneumatic</b>			
NEW 30461	XM1 Scout Advanced Ergonomics Black Synthetic Stock .22 Cal	037084304618	\$329
NEW 30462	XM1 Scout Advanced Ergonomics Black Synthetic Stock .25 Cal	037084304625	\$329
NEW 30463	XM1 Ranger Advanced Ergonomics Black Synthetic Stock .22 Cal	037084304632	\$349
NEW 30464	XM1 Ranger Advanced Ergonomics Black Synthetic Stock .25 Cal	037084304649	\$349
<b>XM1 Hand Pump Combo Pkg. S4 Suppressor/Advanced Ergonomics Stock with Multi-Grip System/PCP</b>			
30408	Advanced Ergonomics Black Synthetic Stock with Fiber-Optic Sights and 4 x 32 Scope .177 Cal., Hand Pump	0037084304083	\$299
30409	Advanced Ergonomics Black Synthetic Stock with Fiber-Optic Sights and 4 x 32 Scope .22 Cal., Hand Pump	0037084304090	\$299
<b>XM1 Bullshark Suppressor/Advanced Ergonomics Stock with Multi-Grip System/Pre-Charged Pneumatic</b>			
30436	Suppressed, Advanced Ergonomics Black Synthetic Stock .177 Cal.	0037084304366	\$479
30437	Suppressed, Advanced Ergonomics Black Synthetic Stock .22 Cal.	0037084304373	\$479
30438	Suppressed, Advanced Ergonomics Black Synthetic Stock .25 Cal.	0037084304380	\$479
<b>S4000-E S3 Suppressor/Advanced Ergonomics Stock with Multi-Grip System/Gas Ram System</b>			
30312	Advanced Ergonomics Black Synthetic Stock with Fiber-Optic Sights .177 Cal./1200 FPS	0037084303123	\$149
30313	Adv. Ergonomics Black Synthetic Stock with Fiber-Optic Sights and 4 x 32 Scope .177 Cal./1200 FPS	0037084303130	\$179
30315	Advanced Ergonomics Black Synthetic Stock with Fiber-Optic Sights .22 Cal./1000 FPS	0037084303154	\$149
30314	Adv. Ergonomics Black Synthetic Stock with Fiber-Optic Sights and 4 x 32 Scope .22 Cal./1000 FPS	0037084303147	\$179
30360	Adv. Ergonomics OD Green Synthetic Stock with Fiber-Optic Sights and 4 x 32 Scope .22 Cal./1000 FPS	0037084303604	\$199
30361	Adv. Ergonomics Hardwood Stock with Fiber-Optic Sights and 4 x 32 Scope .177 Cal./1200 FPS	0037084303611	\$199
30399	Adv. Ergonomics Realtree® Edge™ Synthetic Stock, Fiber-Optic Sights, 4 x 32 Scope .22 Cal./1000 FPS	0037084303994	\$199
30401	Adv. Ergonomics Realtree® Edge™ Synthetic Stock, Fiber-Optic Sights, 4 x 32 Scope .177 Cal./1200 FPS	0037084304014	\$199
<b>S3000-C Advanced Ergonomics Stock with ProAdaptive Checkering</b>			
30316	Advanced Ergonomics Black Synthetic Stock with Fiber-Optic Sights .177 Cal./810 FPS	0037084303161	\$99
30317	Adv. Ergonomics Black Synthetic Stock with Fiber-Optic Sights and 4 x 32 Scope .177 Cal./810 FPS	0037084303178	\$119
30362	Adv. Ergonomics Hardwood Stock with Fiber-Optic Sights and 4 x 32 Scope .177 Cal./810 FPS	0037084303628	\$149
<b>S8000-E TAC Suppressor with AFC Technology - 50% Noise Reduction/Tactical Stock/Gas Ram System</b>			
30433	Advanced Ergonomics Black Synthetic Tactical Stock and 3-9 x 40 Scope .177 Cal./1200 FPS	0037084304335	\$249
30434	Advanced Ergonomics Black Synthetic Tactical Stock and 3-9 x 40 Scope .22 Cal./1000 FPS	0037084304342	\$249
<b>S6000-E Underlever</b>			
30402	Advanced Ergonomics Hardwood Stock with Fiber-Optic Sights and 4 x 32 Scope .177 Cal./1200 FPS	0037084304021	\$229
30403	Advanced Ergonomics Hardwood Stock with Fiber-Optic Sights and 4 x 32 Scope .22 Cal./1000 FPS	0037084304038	\$229
30404	Adv. Ergonomics Black Synthetic Stock with Fiber-Optic Sights and 4 x 32 Scope .177 Cal./1200 FPS	0037084304045	\$199
30406	Adv. Ergonomics Black Synthetic Stock with Fiber-Optic Sights and 4 x 32 Scope .22 Cal./1000 FPS	0037084304069	\$199



PRICE LIST

Item Number	Description	UPC Code	MSRP
<b>ACCESSORY SCOPES</b>			
30130	4 x 32 Scope with two-piece rings and base	0037084301303	\$60
30135	3 - 9 x 40 Scope with Adjustable Objective, one-piece ring and base	0037084301358	\$100
30350	4 x 32 Illuminated Red/Green Scope with two-piece rings and base	0037084303505	\$85
30137	4-16 x 40 Scope mil-dot reticle with Adjustable Objective, two-piece weaver rings	0037084301372	\$120
<b>PRECISION PELLETS .177 Cal. – Tins</b>			
30381	Sampler 35 Pellets Each of X-Match, X-Power, X-Speed, X-Field & X-Hunt; 30 of X-Magnum	0037084303819	\$20
30367	X-Match Supreme Accuracy, Flat Point, Field, Target - 500 ct.	0037084303673	\$15
30368	X-Power Maximum Penetration, Copper-Coated Lead, Dome Point - 500 ct.	0037084303680	\$15
30369	X-Magnum Magnum Shock, High-Impact and Expansion, Heavy Pointed Tip - 300 ct.	0037084303697	\$15
30370	X-Hunt Greater Penetration, Pointed Tip - 500 ct.	0037084303703	\$15
30371	X-Sport Practice, Target, Flat Point- 500 ct.	0037084303710	\$10
*** Tins are listed individually, but must be ordered 10-tins at a time - can be mixed			
<b>PRECISION PELLETS .177 Cal. – Clam Shell Packs</b>			
30345	X-Hunt Greater Penetration, Pointed Tip - 500 ct.	0037084303451	\$20
30346	X-Magnum Magnum Shock, High-Impact and Expansion, Heavy Pointed Tip - 300 ct.	0037084303468	\$20
<b>PRECISION PELLETS .22 Cal. – Tins</b>			
30378	X-Power Maximum Penetration, Copper-Coated Lead, Dome Point - 200 ct.	0037084303789	\$15
30377	X-Magnum Magnum Shock, High-Impact and Expansion, Heavy Pointed Tip - 200 ct.	0037084303772	\$15
30376	X-Hunt Greater Penetration, Pointed Tip - 200 ct.	0037084303765	\$15
*** Tins are listed individually, but must be ordered 10-tins at a time - can be mixed			
<b>PRECISION PELLETS .22 Cal. – Clam Shell Packs</b>			
30347	X-Hunt Greater Penetration, Pointed Tip - 200 ct.	0037084303475	\$20
30348	X-Magnum Magnum Shock, High-Impact and Expansion, Heavy Pointed Tip - 200 ct.	0037084303482	\$20
<b>PREMIUM AIRGUN ACCESSORIES</b>			
30387	Stoeger Airguns Hand Pump - For charging XM1 line of airguns	0037084303871	\$149
30357	Stoeger Airguns Soft Case - Will fit all Stoeger Airguns with or without scopes	0037084303574	\$20
90428	S8000-E TAC Sling	0037084904283	\$10
90430	S8000-E TAC Sling Stud for Picatinny Rail	0037084904306	\$10
90429	S8000-E TAC Bipod for Picatinny Rail	0037084904290	\$35
30351	Single Spinning Metal Target	0037084303512	\$20
30352	Triple Spinning Metal Target	0037084303529	\$20
30353	Airgun Pellet Trap	0037084303536	\$20
30354	Heavy-Paper Airgun Targets - also fits into Trap #30353 - 100 ct.	0037084303543	\$10



For Sales, Customer Service, Accounting and Marketing contact: Stoeger Industries  
 Phone: 800-264-4962 Fax: 301-283-6988 www.stoegerindustries.com Email: info@stoegerindustries.com  
**ONLY SHIP FIREARMS FOR WARRANTY REPAIR TO:** Stoeger Industries, 901 Eighth Street, Pocomoke, MD 21851  
**\*\* Return Authorization Required Prior to Shipment \*\***

